

Eigen-decomposition Techniques for Skywave Interference Detection in Loran-C Receivers

Abbas Mohammed, Fernand Le Roux and David Last *

Department of Telecommunications and Signal Processing
Blekinge Institute of Technology, 372 25 Ronneby, Sweden

* University of Wales, Bangor, UK

E-mail: abbas.mohammed@bth.se

Abstract

The high-resolution ESPRIT eigen-decomposition technique is applied to the problem of estimating the delay of Loran-C skywaves. The performance of this technique is evaluated and compared with Fourier-based methods. The simulation results show that the ESPRIT algorithm yields good estimation accuracy and that it can also operate successfully with noisy signals. Results using off-air data confirm these conclusions.

1 Introduction

Loran-C is a pulsed, low-frequency (100 kHz), hyperbolic, radio-navigation system for position fixing by reference to terrestrial transmitting stations. Although a long-established and well-known system, Loran is currently being studied intensively in its role as a complement to GNSS [e.g. FAA, LORIPP, LORAPP programmes]. The US Volpe Report and other documents have demonstrated the vulnerability of GNSS to accidental and intentional interference and identified Loran as a most promising complement, since it shares almost no vulnerabilities with GNSS. This enhanced interest in Loran has focussed in part on the technology of receivers. As a result, the application of advanced digital signal processing techniques has produced dramatic improvements in receiver performance.

Among the properties of Loran undergoing intensive evaluation currently is its integrity and, specifically, the confidence with which cycles of the 100 kHz signal can be identified within the Loran pulses. This paper makes a contribution to that discussion since it addresses the question of skywave contamination.

To explain, Loran-C employs the ground-wave components of the transmitted signals for position determination since their propagation velocities are normally exceptionally stable in time. However, noise affects the received signals. Also, various propagation effects and the front-end filters of receivers alter the shapes of the received pulses. These factors all lead to inaccuracies in the measured positions. So, too, do unwanted skywave signal components received via ionospheric paths.

The ability of Loran-C receivers to resist this skywave contamination is its major advantage over earlier continuous-wave low-frequency navigation aids. As a consequence of the techniques employed, a single chain of Loran-C transmitters can provide coverage of a large geographical area.

It is conventionally assumed that Loran-C receivers avoid skywave contamination by processing only samples taken prior to the arrival of the first skywave component, typically 35-60 μs after the groundwave. This technique has significant limitations when implemented in receivers of finite bandwidth, since such receivers increase the rise times of the Loran-C pulses and substantially reduce the amplitudes of the groundwave signals at the sampling point. As a result, many current receivers are designed to take samples later in the pulse and consequently suffer skywave errors. An attractive solution to the skywave problem is a receiver that adaptively adjusts the sampling point (for each station) to the optimal value as the skywave delay varies. Such techniques should enable the receiver to minimise the errors due to skywave interference while maximising signal-to-noise and signal-to-interference ratios.

The question of skywave contamination, and receivers' ability to deal with it, are currently of especial interest to those studying the question of the exceptionally *early skywaves* which appear to affect signals received at higher latitudes, such as at sites in Alaska [1, 2].

At previous ILA Conventions and in recent publications we have demonstrated the feasibility of using Fourier-based and other high-resolution techniques for estimating the skywave delays of Loran-C signals. In those papers, we demonstrated that the problem of estimating the arrival times of the groundwave and skywave components of a Loran-C signal is analogous to that of isolating the components of a composite signal in the frequency domain. That has let us take advantage of recent advances in frequency-domain signal-processing techniques. The principle of one of the most recent of such techniques, based on the eigendecomposition approach, will be explained, and we will show how it can be modified to make it suitable for detecting the onset of skywaves in Loran-C receivers.

We will assess the performance of this new eigendecomposition approach when used to identify and measure skywave components, and compare it with those of previous-investigated algorithms. Of eigendecomposition algorithms, the relatively-new ESPRIT algorithm [3]-[6] appears particularly promising and superior to the other algorithms investigated previously [7].

The paper will employ for these tests a mathematical model of a Loran-C signal that describes it in the time and frequency domains. The proposed new skywave detection technique will be reviewed and its principal limitations discussed. Its performance will be assessed by theoretical analysis, by computer simulation under a range of realistic conditions, and by the use of off-air signals recorded in real time by a receiver.

2 Loran-C Signal Model

It was shown in [7] that the received Loran-C signal may be represented in either the time domain or the frequency domain. This composite signal consists of the groundwave and skywaves, plus noise and interference. The signal model used in estimating skywave delay assumes that the skywaves pulses have the same shape as the groundwave but that they are delayed in time and scaled in amplitude. Therefore, the composite signal $x_c(t)$

can be expressed in the time domain as:

$$x_c(t) = x_g(t) + \sum_{n=1}^N k_n x_g(t - \tau_n) + w(t) \quad (1)$$

where $x_g(t)$ is the groundwave signal and $w(t)$ is the noise. The amplitude and delay of the n -th skywave component relative to the groundwave, are represented by k_n and τ_n , respectively.

By taking the Fourier Transform of eqn. (1), we obtain the equivalent representation of the composite signal in the frequency domain:

$$X_c(f) = X_g(f) \left[1 + \sum_{n=1}^N k_n e^{j2\pi f \tau_n} \right] + W(f) \quad (2)$$

where $X_c(f)$, $X_g(f)$ and $W(f)$ are the Fourier Transform of $x_c(t)$, $x_g(t)$ and $w(t)$, respectively.

Equations (1) and (2) constitute the signal model which will be used in estimating the Loran-C skywave parameters. This model is valid for Fourier and eigen-based techniques.

3 Fourier-based IFFT Technique

In this section we briefly present a well known technique based on Fourier analysis for the purpose of skywave identification in Loran-C receivers. This technique is known as the spectral-division Inverses Fast Fourier Transform algorithm, or simply the IFFT algorithm, which has been shown to provide good performance and robustness.

As shown in [7], we start by dividing the spectrum of the signal in eqn. (2) by the spectrum of a standard Loran-C pulse. This is the *spectral-division* concept. We then return to the time domain by taking the Inverse Fourier Transform of the result. This process can be represented mathematically as:

$$F^{-1} \left\{ \frac{X_c(f)}{X_0(f)} \right\} = k_g \left[\delta(t) + \sum_{n=1}^N k_n \delta(t - \tau_n) \right] + F^{-1} \left\{ \frac{W(f)}{X_0(f)} \right\} \quad (3)$$

where F^{-1} represents the Inverse Fourier Transform operator, $X_0(f)$ is the spectrum of the normalised standard Loran-C pulse $x_0(t)$; k_g is a constant related to the amplitude of the groundwave. From the time domain expression in eqn. (3) we observe impulses at the arrival times of the groundwave and skywave components, from which the onset skywave delay can be found.

4 Eigen-decomposition Frequency Estimation Techniques

This section describes the principle of frequency estimation using eigen-decomposition techniques. Considerable research has been directed to these techniques in recent years because of their superior ability to resolve closely-spaced frequencies of multiple, superimposed, sinusoids in noisy signals [3]-[6]. In particular, we have employed an eigen-decomposition technique, using the *Estimation of Signal Parameters via Rotational Invariance Techniques* (ESPRIT) algorithm, in place of the IFFT in eqn. (3). We will

discuss first the mathematical treatment of the eigen-decomposition techniques followed by the analysis of ESPRIT algorithm.

4.1 Eigen-decomposition Analysis Principle

Consider a signal $x(n)$ that contains P complex exponential signals $s(n)$ and additive white Gaussian noise $w(n)$; that is:

$$x(n) = s(n) + w(n), \quad (4)$$

and

$$s(n) = \sum_{p=1}^P A_p e^{j2\pi f_p n + \theta_p}. \quad (5)$$

where A_p , f_p and θ_p denote the amplitudes, frequencies and the phases of the complex exponential signals. The $(M \times M)$ autocorrelation matrix $\hat{\mathbf{R}}_{\mathbf{x}}$ of the signal $x(n)$ is defined by:

$$\hat{\mathbf{R}}_{\mathbf{x}} = \mathbf{E}\{\mathbf{x}(n)\mathbf{x}^H(n)\} = \mathbf{A}\mathbf{P}\mathbf{A}^H + \sigma_w^2 \mathbf{I}, \quad (6)$$

where σ_w^2 is the noise variance. The $\mathbf{x}(n)$ signal vector is given by:

$$\mathbf{x}(n) = [x(n), \dots, x(n - M + 1)]^T \quad (M \times 1). \quad (7)$$

and \mathbf{A} is an $(M \times P)$ matrix of rank P which contains the exponential elements:

$$\mathbf{A} = [\mathbf{a}(f_1), \mathbf{a}(f_2), \dots, \mathbf{a}(f_P)] \quad (M \times P), \quad (8)$$

where

$$\mathbf{a}(f) = [1, e^{-j2\pi f}, \dots, e^{-j(M-1)2\pi f}]^T \quad (M \times 1). \quad (9)$$

The matrix \mathbf{I} is the $(M \times M)$ identity matrix and \mathbf{P} is an $(M \times P)$ diagonal matrix with the powers, A_p^2 , of the P exponentials:

$$\mathbf{P} = \begin{bmatrix} A_1^2 & & 0 \\ & \ddots & \\ 0 & & A_P^2 \end{bmatrix} \quad (M \times P). \quad (10)$$

The eigen-decomposition of the autocorrelation matrix $\hat{\mathbf{R}}_{\mathbf{x}}$ is defined as:

$$\hat{\mathbf{R}}_{\mathbf{x}} = \mathbf{U}\mathbf{\Lambda}\mathbf{U}^H = \sum_{n=0}^{M-1} \lambda_n \mathbf{u}_n \mathbf{u}_n^H, \quad (11)$$

where \mathbf{U} is the eigenvector matrix defined as:

$$\mathbf{U} = [u_1, u_2, \dots, u_M], \quad (12)$$

and $\mathbf{\Lambda}$ is the eigenvalue diagonal matrix

$$\mathbf{\Lambda} = \begin{bmatrix} \lambda_1 & & 0 \\ & \ddots & \\ 0 & & \lambda_M \end{bmatrix} \quad (M \times M). \quad (13)$$

The eigenvalues of the diagonal matrix $\mathbf{\Lambda}$ of $\hat{\mathbf{R}}_{\mathbf{x}}$ are ordered as $\lambda_1 \geq \lambda_2 \geq \dots \geq \lambda_M > 0$ and \mathbf{U} is the related eigenvectors. The eigenvalues and the related eigenvectors can be divided into a noise eigenvector matrix with the related eigenvalues $\lambda_{n+1} = \dots = \lambda_M = \sigma_w^2$, and a signal eigenvector matrix with the related eigenvalues $\lambda_1 \geq \dots \geq \lambda_M > \sigma^2$. Hence, we can decompose $\hat{\mathbf{R}}$ as the sum of two autocorrelation matrices: the noise covariance matrix $\hat{\mathbf{R}}_{\mathbf{w}}$ and the signal covariance matrix $\hat{\mathbf{R}}_{\mathbf{s}}$ defined respectively by:

$$\hat{\mathbf{R}}_{\mathbf{w}} = \mathbf{U}_{\mathbf{w}}\mathbf{\Lambda}_{\mathbf{w}}\mathbf{U}_{\mathbf{w}}^{\mathbf{H}} = \sigma_{\mathbf{w}}^2\mathbf{I}, \quad (14)$$

$$\hat{\mathbf{R}}_{\mathbf{s}} = \mathbf{U}_{\mathbf{s}}\mathbf{\Lambda}_{\mathbf{s}}\mathbf{U}_{\mathbf{s}}^{\mathbf{H}} = \mathbf{A}\mathbf{P}\mathbf{A}^{\mathbf{H}}, \quad (15)$$

where matrix $\mathbf{U}_{\mathbf{s}}$ contains the signal eigenvectors and is written as:

$$\mathbf{U}_{\mathbf{s}} = \mathbf{A}\mathbf{T}. \quad (16)$$

The full-rank matrix \mathbf{T} has the same subspace sizes as the complex exponential matrix \mathbf{A} and the signal matrix $\mathbf{U}_{\mathbf{s}}$. Finally, a frequency estimation algorithm can be used to extract estimate of the frequencies and related parameters. One such eigen-decomposition frequency estimation technique is the ESPRIT algorithm discussed in the next section.

4.2 The ESPRIT Algorithm

In this section we explain the principle of estimating the frequencies of exponential signals in noise using the ESPRIT algorithm. We start by generating the autocorrelation matrix $\hat{\mathbf{R}}_{\mathbf{x}}$, size $(M \times M)$, of the signal using eqn. (6) and then we employ the eigen-decomposition analysis in order to find its eigenvectors and the related eigenvalues.

The signal eigenvector matrix $\mathbf{U}_{\mathbf{s}}$ is formed by taking the P eigenvectors related to the largest eigenvalues $\lambda_{\mathbf{s}}$. We define two sub-matrices \mathbf{A}_1 and \mathbf{A}_2 , respectively, as follows:

$$\mathbf{A}_1 = \begin{bmatrix} \mathbf{I}_{M-1} & \mathbf{0} \end{bmatrix} \mathbf{A}, \quad (17)$$

$$\mathbf{A}_2 = \begin{bmatrix} \mathbf{0} & \mathbf{I}_{M-1} \end{bmatrix} \mathbf{A}. \quad (18)$$

where the construction of the matrix \mathbf{A} is shown in eqn. (8). The sub-matrices are arranged such that \mathbf{A}_1 contains the first $M - 1$ rows of \mathbf{A} , and \mathbf{A}_2 contains the last $M - 1$ rows of \mathbf{A} , respectively. This is called the *shift structure*. \mathbf{I}_{M-1} is an identity matrix of size $(M - 1) \times (M - 1)$. The matrices $\begin{bmatrix} \mathbf{I}_{M-1} & \mathbf{0} \end{bmatrix}$ and $\begin{bmatrix} \mathbf{0} & \mathbf{I}_{M-1} \end{bmatrix}$ are $(M - 1) \times M$, and $\mathbf{0}$ is a vector with zeros. The relation of \mathbf{A}_1 to \mathbf{A}_2 is given by:

$$\mathbf{A}_2 = \mathbf{A}_1\mathbf{D}, \quad (19)$$

where \mathbf{D} is

$$\mathbf{D} = \begin{bmatrix} e^{-j2\pi f_1} & & 0 \\ & \ddots & \\ 0 & & e^{-j2\pi f_i} \end{bmatrix} \quad (P \times P). \quad (20)$$

The matrix \mathbf{D} is a diagonal matrix which contains the frequency elements $e^{-j2\pi f_i}$. The

eigenvector matrix \mathbf{U}_s corresponding to the signal subspace can also be divided into two similar sub-matrices which are defined as follows:

$$\mathbf{U}_{s_1} = \begin{bmatrix} \mathbf{I}_{M-1} & \mathbf{0} \end{bmatrix} \mathbf{U}_s, \quad (21)$$

and

$$\mathbf{U}_{s_2} = \begin{bmatrix} \mathbf{0} & \mathbf{I}_{M-1} \end{bmatrix} \mathbf{U}_s. \quad (22)$$

The relation of \mathbf{U}_{s_1} to \mathbf{U}_{s_2} is given by:

$$\mathbf{U}_{s_2} = \mathbf{U}_{s_1} \hat{\mathbf{\Phi}}, \quad (23)$$

where $\hat{\mathbf{\Phi}}$ is found by least squares approximation:

$$\hat{\mathbf{\Phi}} = \left(\mathbf{U}_{s_1}^T \mathbf{U}_{s_1} \right)^{-1} \mathbf{U}_{s_1}^T \mathbf{U}_{s_2}. \quad (24)$$

It can be shown that $\hat{\mathbf{\Phi}}$ is related to \mathbf{D} by:

$$\hat{\mathbf{\Phi}} = \mathbf{T}^{-1} \mathbf{D} \mathbf{T}. \quad (25)$$

It can be seen from eqn. (19) that both \mathbf{D} and $\hat{\mathbf{\Phi}}$ have the same eigenvalues. Using this result, the estimation of the frequencies f_i of the signal can be accomplished by using the following equation:

$$f_i = \frac{-\arg(\lambda_i)}{2\pi}, \quad (26)$$

Where λ_i are the eigenvalues of $\hat{\mathbf{\Phi}}$.

5 Performance Evaluation

This section evaluates the performance of the algorithms under noisy conditions. The evaluation will be conducted by means of computer simulation employing a Monte Carlo method and by the use of off-air data. The simulation setup is discussed first, followed by the simulation results.

5.1 Simulation Setup

In this section the Matlab implementation of the combined Loran-C and skywave estimation system will be explained. The simulation setup contains *three* channels: the signal generation channel, the receiver front-end channel and the skywave estimation channel. The functional block diagram of the simulation program is shown in Figure 1.

The Program Control sets up the initial parameters in all the functional blocks and controls their operations. Simulated Atmospheric Noise (SAN), generated in accordance with the standard defined in the Loran-C Minimum Performance Standards (MPS) [8], is added to the separately generated Loran-C groundwave and skywaves. The parameters α and β control the signal-to-noise ratio (SNR) and the skywave-to-groundwave ratio (SGR) of the system. The composite signal is then fed into a program block which simulates the filtering effect of the front-end of the receiver, then input to the Skywave Detection Algorithm under test which analyses it to determine the times of arrival of the skywave components.

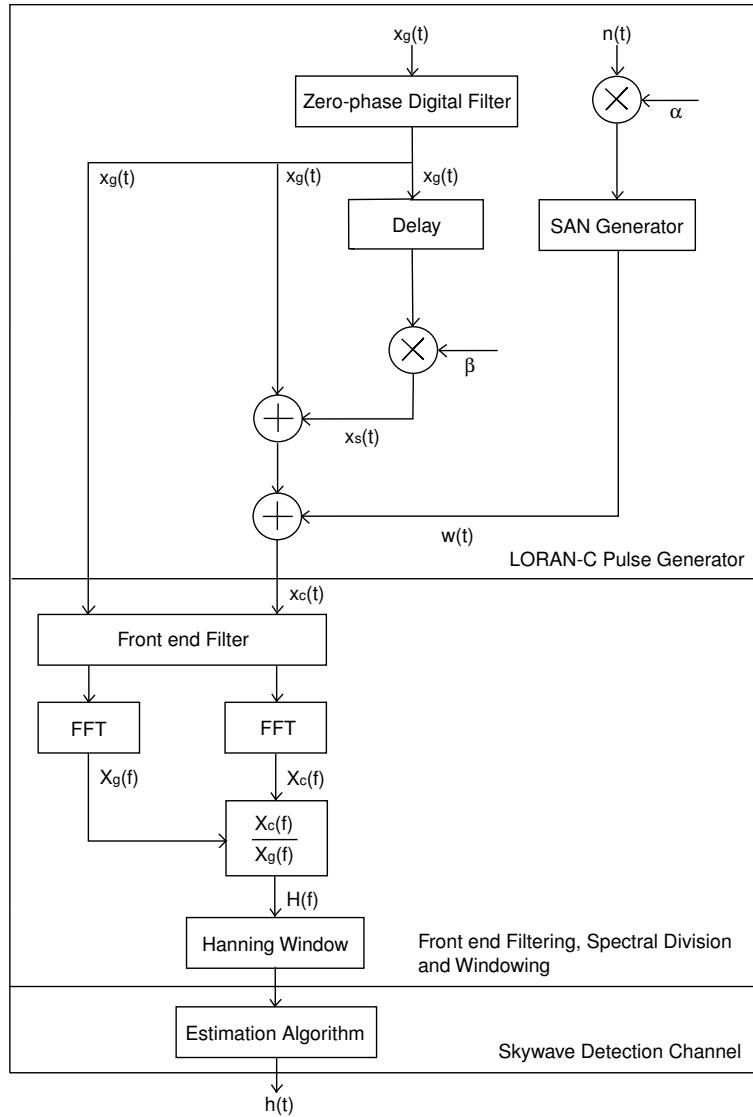
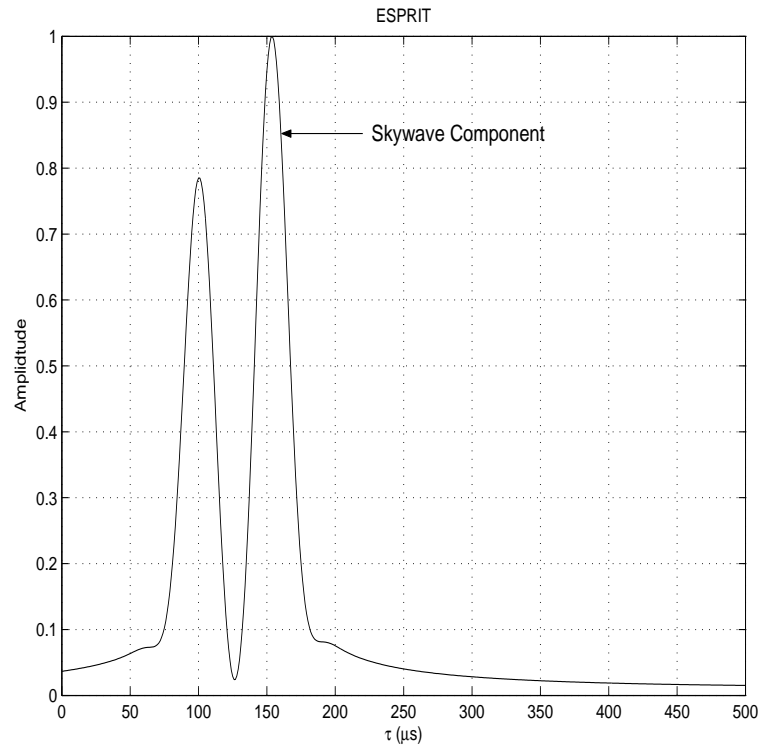

Figure 1: *Functional block diagram of the programs to simulate the different algorithms to detect the skywaves under noisy conditions.*

5.2 Simulation Results

A skywave delay estimation simulator has been developed to evaluate the performance of the new ESPRIT algorithm and the results are compared with the IFFT spectral-division method. Figure 2 shows typical results of the simulations when the signal consists of a groundwave component at $100 \mu\text{s}$ followed by a skywave component $50 \mu\text{s}$ later and 12 dB stronger, a typical night-time skywave condition. The SNR is equivalent to -13 dB at the antenna input; this is 3 dB below the USCG minimum and corresponds to a simulation signal SNR of 24 dB. With this set of parameters both algorithms produced satisfactory results; the groundwave and skywave components of the signal are well separated and easily identified. However, the resolution is better in the ESPRIT algorithm than with the IFFT method.



(a)

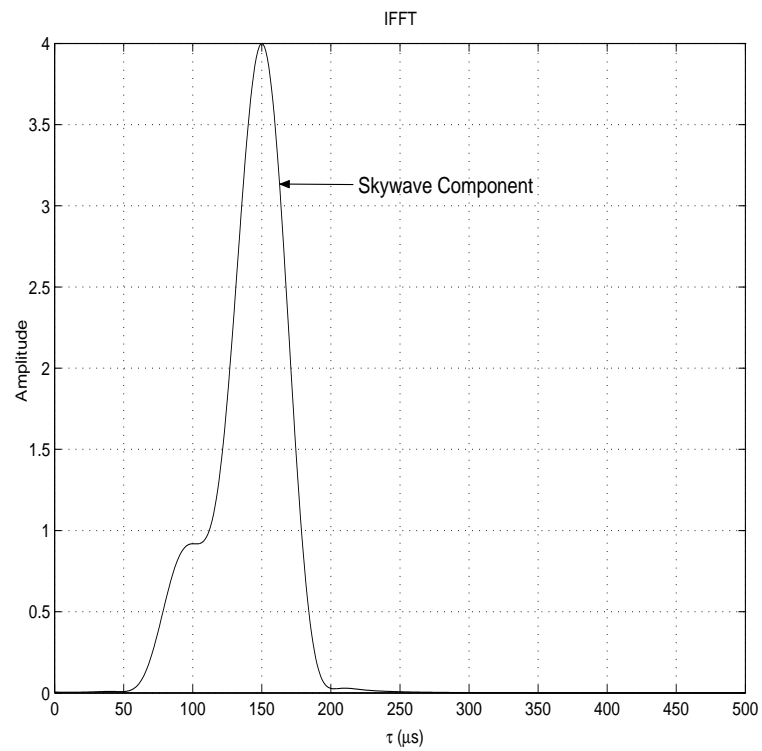

(b)

Figure 2: Groundwave and skywave components separated by: (a) The ESPRIT algorithm, and (b) The FFT spectral-division method. Skywave delay = $50 \mu\text{s}$, SNR = -13 dB (at the receiver input) and SGR = 12 dB .

To validate the result in Figure 2a, the estimates made by the ESPRIT algorithm over 100 individual runs of the simulation were recorded. Figure 3 clearly shows that the algorithm produce accurate results and good resolution.

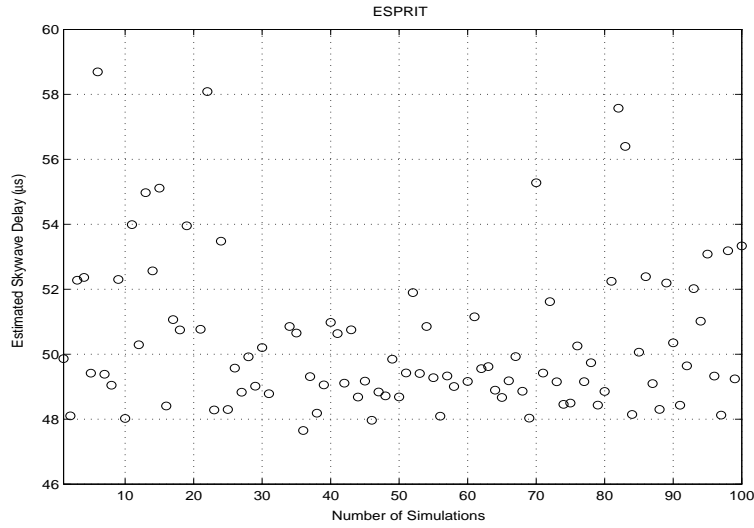

Figure 3: Skywave delay estimates made by ESPRIT algorithm. The Skywave delay = $50 \mu s$, $SGR = 12 \text{ dB}$ and $SNR = -13 \text{ dB}$ (at the receiver input).

The ESPRIT method has been further evaluated using off-air data collected by Offermans. Figure 4 shows an example of data received at Delft (Netherlands) from the Loran-C station at Sylt (Germany). Figures 5a and 5b show the results of analysing it using the ESPRIT and IFFT algorithms, respectively. A skywave delay of $96 \mu s$ (ESPRIT) and $100 \mu s$ (IFFT) is estimated. This is the *first time* Loran-C skywave delays have been estimated using the ESPRIT algorithm.

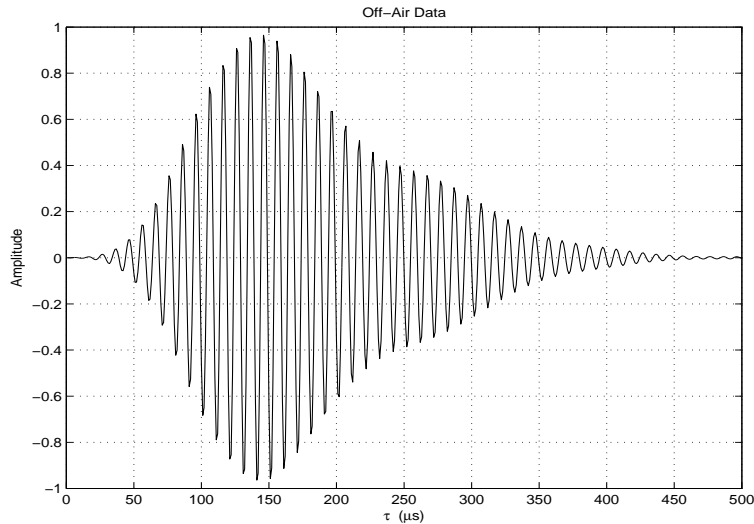
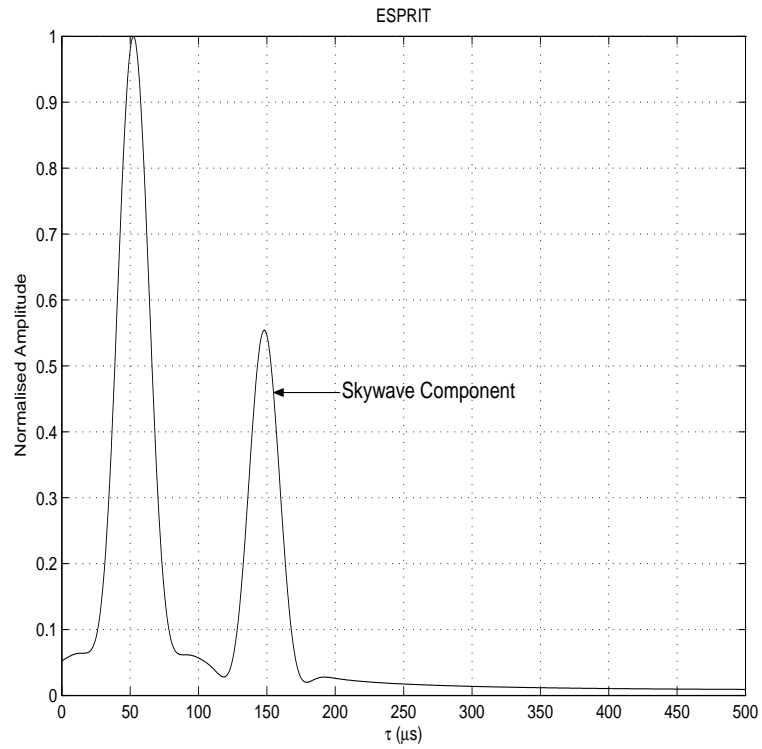
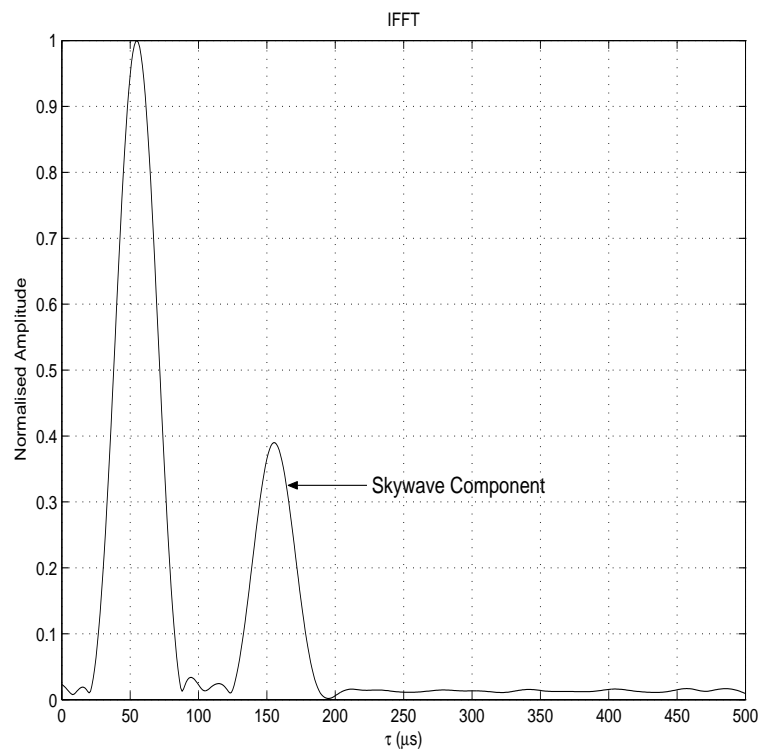

Figure 4: Off-air signals received at Delft (The Netherlands) from the Loran-C station at Sylt (Germany).



(a)



(b)

Figure 5: Groundwave and skywave components of the Off-air data separated by: (a) The ESPRIT algorithm, and (b) The IFFT spectral-division method.

6 Conclusions

The ESPRIT high-resolution estimation technique, based on eigendecomposition analysis, has been used to estimate the delays of the skywave components of Loran-C signals. The technique has been shown to resolve closely-spaced groundwave and skywave components of the signals and to provide good resolution. The paper has also demonstrated the performance of the new technique for the *first time* using off-air signals. In future research we will attempt to tune the algorithms to detect the exceptionally *early* skywave signals at high latitudes that are currently of great interest.

7 Acknowledgements

The authors thank Gerard Offermans, Professor Durk van Willigen and other colleagues at Reelektronica B.V., Netherlands, for the use of their off-air data.

References

- [1] B. Peterson et. al., "Early Skywave Propagation", *Proceeding of the 32nd Annual Technical Symposium, International Loran Association*, Colorado, USA, November 2003.
- [2] B. Peterson et. al., "Mitigation of the Effects of Early Skywave", *Proceeding of the 32nd Annual Technical Symposium, International Loran Association*, Colorado, USA, November 2003.
- [3] R. Roy and T. Kailath, "ESPRIT - Estimation of Signal Parameters via Rotational Invariance Techniques", *IEEE ASSP*, Vol. 37, No. 7, pp. 984-995, July 1989.
- [4] B. D. Roa and K. S. Arun, "Model Based Processing of Signals: A State Space Approach", *Proc. IEEE*, Vol. 80, No. 2, pp. 283-309, February 1992.
- [5] R. L. Johnson, "An Experimental Investigation of Three Eigen DF Techniques", *IEEE Trans. on Aerospace and Electronic Systems*, Vol. 28, No. 3, pp. 852-860, July 1992.
- [6] R. Roy, A. Paulraj, T. Kailath, "ESPRIT - A Subspace Rotation Approach to Estimation of Parameters of Cisoids in Noise", *IEEE ASSP*, Vol. 34, No. 5, pp. 1340-1342, October 1986.
- [7] A. Mohammed and J. D. Last, "Novel Signal Processing Techniques for Detecting and Minimizing Skywave Interference in LORAN-C Receivers", *Navigation, Journal of the Institute of Navigation*, Vol. 46, No. 3, pp. 147-159, February 1999.
- [8] "Radio Technical Commission for Marine Services, U.S. Federal Communication Commission", *Minimum Performance Standards (MPS) - Marine Loran-C Receiving Equipments*, March 1977.

Biographies

Dr. Abbas Mohammed is an Associate Professor and Head of the Radio Communications and Navigation Reserach Group at Blekinge Institute of Technology, Sweden. He was awarded the Swedish "Docent degree" (equivalent to 2 PhD degrees in different fields of research) in Radio Communications and Navigation from Blekinge Institute of Technology in 2001, and the PhD degree by the University of Liverpool, United Kingdom, in 1992. From 1993 to 1996 he was a Post-Doctoral Research Fellow in the Radio Navigation Group at the University of Wales, Bangor. He has published many papers on telecommunication systems and the detection and minimization of skywave interference in Loran-C receivers. He is a member of IEEE, IEE, IEICE, a life member of ILA and an Associate Fellow of the Royal Institute of Navigation. He is also a Board Member of IEEE Signal Processing Swedish Chapter. He was the Editor for a special issue "Advances in Signal Processing for Mobile Communication Systems" of Wiley's International Journal of Adaptive Control and Signal Processing, Fall 2002.

Mr. Fernand Le Roux completed BSc in Electrical Engineering of Hanze Hogeschool Groningen, The Netherlands in 2001 and MSc in Electrical Engineering emphasis in Signal Processing and Telecommunication at Blekinge Institution of Technology, Ronneby, Sweden in 2003. He presented and published his first paper, at the 32nd International LORAN Association conference in Boulder, Colorado, USA in 2003, which was a part of his MSc Thesis study. Currently he works as a research engineer at the Department of Telecommunication and Signal Processing, Blekinge Institution of Technology, Ronneby, Sweden.

Professor David Last holds a Personal Chair in the University of Wales and is Head of the Radio-Navigation Group at Bangor. He was awarded the university degrees of BSc(Eng) at Bristol, England, in 1961, a PhD at Sheffield, England, in 1966, and a DSc by the University of Wales in 1995. Prof. Last is Vice-President and holder of the Medal of Merit of the International Loran Association. He is a former Vice-President of the Royal Institute of Navigation, a Fellow of the Institution of Electrical Engineers and a Chartered Engineer. He has published many papers on navigation systems, including Loran-C, Decca Navigator, Argos, Omega, Marine Radiobeacons, GPS and DGPS. In Loran, he has specialised in understanding signal propagation and employing that knowledge to predict system coverage and ASFs. He has also developed receiver techniques for measuring skywave delays. He acts as a Consultant on radio-navigation and communications to companies and to governmental and international organisations. He is an instrument-rated pilot and user of terrestrial and satellite navigation systems.